

BANTAM PHONE PLUG TEST CABLES

Details: The frame is nickel plated machined brass. All internal insulation is injection molded nylon. The handle is a black molded flexible rubber cover. All connections are soldered.

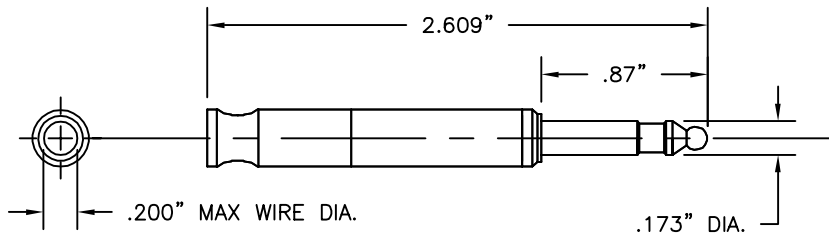

Part No.	Description
9320	Bantam Plug

PATCH CORD BANTAM PLUG TO BANTAM PLUG

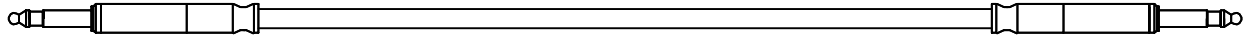

Standard Lengths Available:

Part No.	Cable
2626-(length)	2200 Series

18"	45cm	36"	90cm
24"	60cm	48"	120cm
30"	75cm	60"	150cm

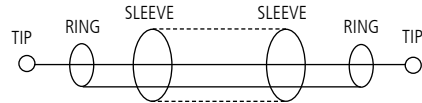

E-Z-MICRO-HOOKS TO BANTAM PHONE PLUG

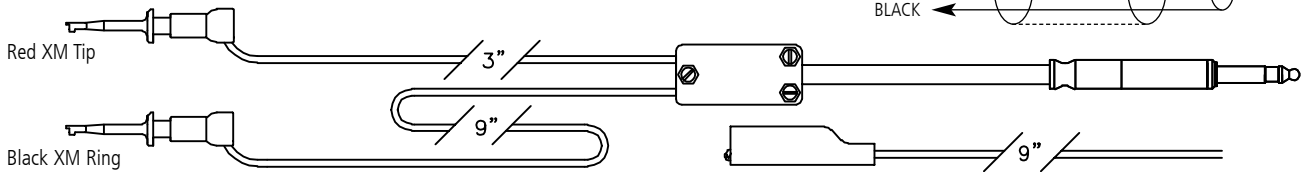

Cable with XM Ring

Part No.	Cable	Tip	Ring
2620XM-(lgth)	2200 Series	XM	XM

Cable With Part No. 9275 Miniature Alligator Ring

Part No.	Cable	Tip	Ring
2621XM-(lgth)	2200 Series	XM	Mini Gator

E-Z-MINI HOOKS TO BANTAM PHONE PLUG

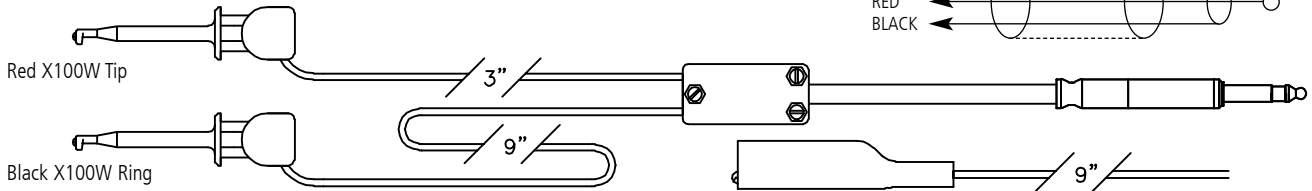

Cable with X100W Ring

Part No.	Cable	Tip	Ring
2620-(lgth)	2200 Series	X100W	X100W

Cable With Part No. 9274 Standard Alligator Ring

Part No.	Cable	Tip	Ring
2621-(lgth)	2200 Series	X100W	Std. Gator

E-Z-MINI XR HOOKS TO BANTAM PHONE PLUG

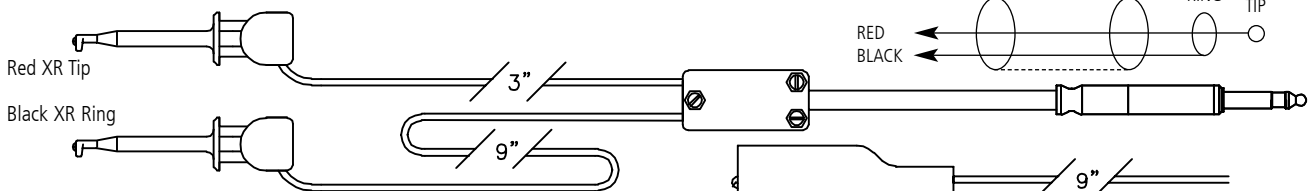

Cable with XR Ring

Part No.	Cable	Tip	Ring
2620XR-(lgth)	2200 Series	XR	XR

Cable With Part No. 9274 Standard Alligator Ring

Part No.	Cable	Tip	Ring
2621XR-(lgth)	2200 Series	XR	Std. Gator

BANTAM PHONE PLUG TEST CABLES

DOUBLE GRIPPER TO BANTAM PHONE PLUG

Red XK Tip
Black XK Ring

Cable With XK Ring

Part No.	Cable	Tip	Ring
2620XK -(lgth)	2200 Series	XK	XK

RED
BLACK

SLEEVE
RING
TIP

Cable With Part No. 9275 Miniature Alligator Ring

Part No.	Cable	Tip	Ring
2621XK -(lgth)	2200 Series	XK	Mini Gator

ALLIGATOR CLIPS TO BANTAM PHONE PLUG

Red Gator Tip
Black Gator Ring

Cable With Part No. 9274 Standard Alligators and 18 AWG Leads

Part No.	Cable	Tip	Ring
2629 -(lgth)	2200 Series	Std. Gator	Std. Gator

RED
BLACK

SLEEVE
RING
TIP

Cable With Part No. 9275 Miniature Alligator Ring and 20 AWG Leads

Part No.	Cable	Tip	Ring
2629M -(lgth)	2200 Series	Mini Gator	Mini Gator

THREE ALLIGATOR CLIPS TO BANTAM PHONE PLUG

Red Tip
Black Ring
Green Sleeve

Cable With Part No. 9274 Standard Alligators

Part No.	Cable	Tip	Ring	Sleeve
2628 -(lgth)	2200 Series	Std. Gator	Std. Gator	Std. Gator

GREEN
RED
BLACK

SLEEVE
RING
TIP

Cable With Part No. 9275 Miniature Alligators

Part No.	Cable	Tip	Ring	Sleeve
2628M -(lgth)	2200 Series	Mini Gator	Mini Gator	Mini Gator

SHIELDED BALANCE LINE, DOUBLE BANANA PLUGS TO BANTAM PHONE PLUG

18 AWG
4" Lead Green

Standard Lengths Available:

18"	45cm	36"	90cm
24"	60cm	48"	120cm
30"	75cm	60"	150cm

SHIELD
HOT
GRND

SLEEVE
RING
TIP

Part No.	Cable
2605 -(Length)	2200 Series

1/4" PHONE PLUG (WE-310 / PJ051) TEST CABLES

Details: 1/4" Phone Plug is a functional equivalent to both the WE-310 and PJ-051. Frame is machined brass. All internal insulation is injection molded nylon. A red or black zinc die cast handle is also part of a chuck-type strain-relief clamp that accepts cables from .100" to .280" in diameter. Internal connections are soldered.

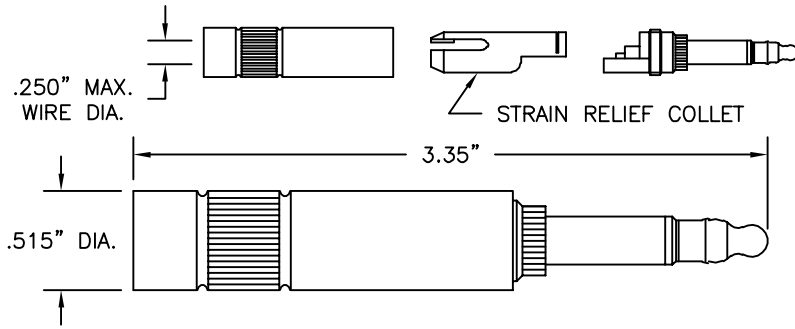

Part No.	Description
9322-(color)	Phone Plug

PATCH CORD WE-310 PHONE PLUG EACH END (PJ-051 Equivalent)

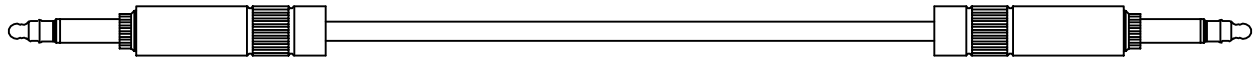

Standard Lengths Available:

Part No.	Cable
2502-(lgth)	2100 Series

18"	45cm	36"	90cm
24"	60cm	48"	120cm
30"	75cm	60"	150cm

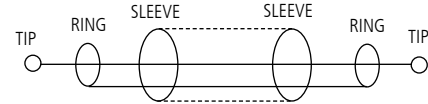

E-Z-MICRO-HOOKS TO WE-310 PHONE PLUG (PJ-051 EQUIVALENT)

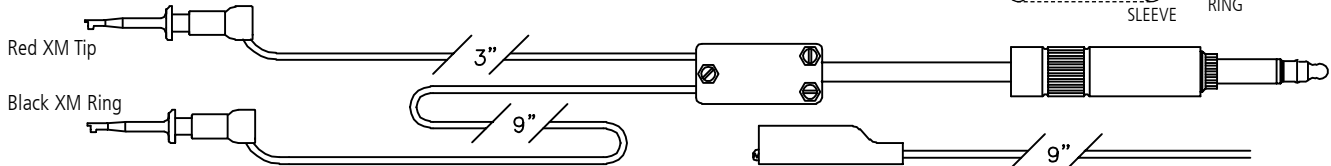

Cable with XM Ring

Part No.	Cable	Tip	Ring
2520XM-(lgth)	2100 Series	X100W	X100W
3020XM-(lgth)	Twisted Pair	X100W	X100W

Cable with Part No. 9275 Miniature Alligator Ring

Part No.	Cable	Tip	Ring
2521XM-(lgth)	2100 Series	XM	Mini Gator
3021XM-(lgth)	Twisted Pair	XM	Mini Gator

E-Z MINI HOOKS TO WE-310 PHONE PLUG (PJ-051 EQUIVALENT)

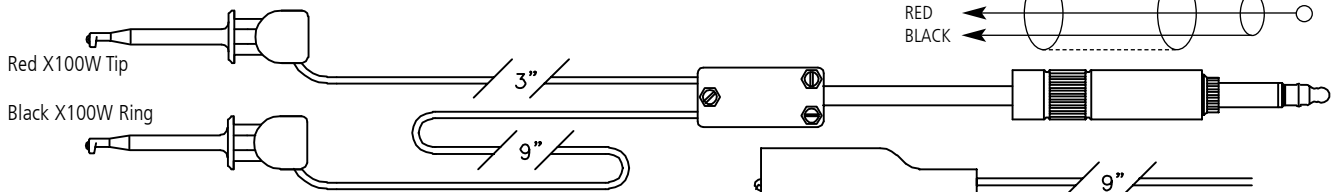

Cable with X100W Ring

Part No.	Cable	Tip	Ring
2520-(lgth)	2100 Series	X100W	X100W
3020-(lgth)	Twisted Pair	X100W	X100W

Cable with Part No. 9274 Standard Alligator Ring

Part No.	Cable	Tip	Ring
2521-(lgth)	2100 Series	X100W	Std. Gator
3021-(lgth)	Twisted Pair	X100W	Std. Gator

E-Z MINI XR HOOKS TO WE-310 PHONE PLUG (PJ-051 EQUIVALENT)

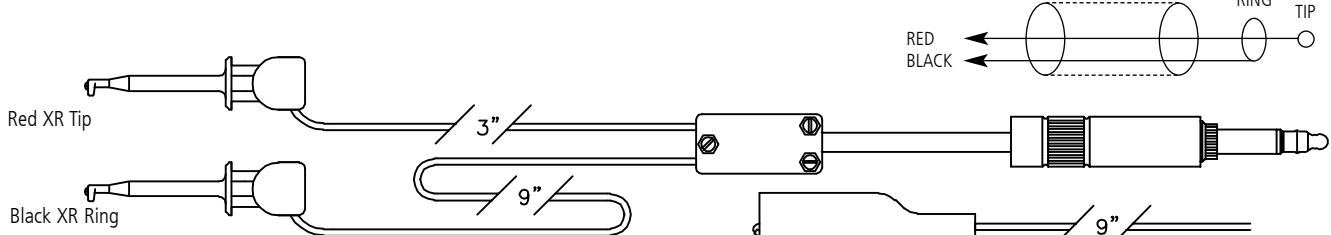

Cable with XR Ring

Part No.	Cable	Tip	Ring
2520XR-(lgth)	2100 Series	XR	XR
3020XR-(lgth)	Twisted Pair	XR	XR

Cable with Part No. 9274 Standard Alligator Ring

Part No.	Cable	Tip	Ring
2521XR-(lgth)	2100 Series	XR	Std. Gator
3021XR-(lgth)	Twisted Pair	XR	Std. Gator

1/4" PHONE PLUG (WE-310 / PJ051) TEST CABLES

DOUBLE GRIPPER TO WE-310 PHONE PLUG (PJ-051 EQUIVALENT)

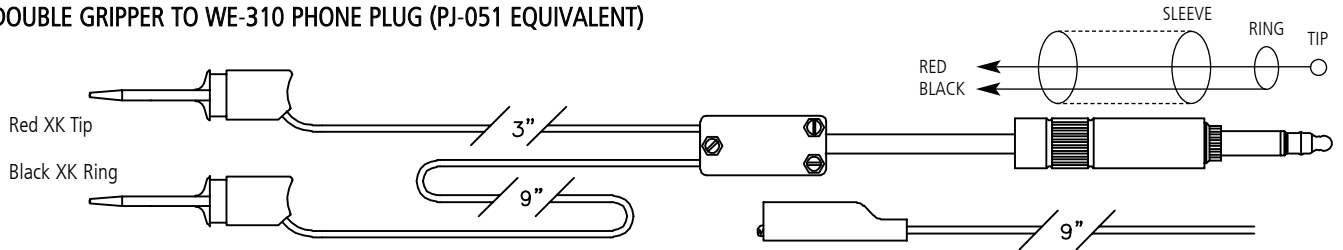

Cable with XK Ring

Part No.	Cable	Tip	Ring
2520 XK-(lgth)	2100 Series	XK	XK
3020 XK-(lgth)	Twisted Pair	XK	XK

Cable with Part No. 9275 Miniature Alligator Ring

Part No.	Cable	Tip	Ring
2521 XK-(lgth)	2100 Series	XK	Mini Gator
3021 XK-(lgth)	Twisted Pair	XK	Mini Gator

ALLIGATOR CLIPS TO WE-310 PHONE PLUG (PJ-051 EQUIVALENT)

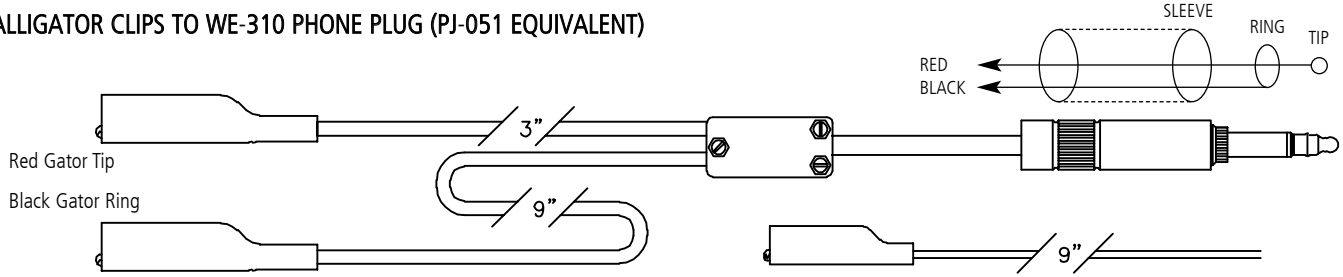

Cable with Part No. 9274 Standard Alligators and 18 AWG Leads

Part No.	Cable	Tip	Ring
2529-(lgth)	2100 Series	Std. Gator	Std. Gator
3029-(lgth)	Twisted Pair	Std. Gator	Std. Gator

Cable with Part No. 9275 Miniature Alligator Ring and 20 AWG Leads

Part No.	Cable	Tip	Ring
2529 M-(lgth)	2100 Series	Mini Gator	Mini Gator
3029 M-(lgth)	Twisted Pair	Mini Gator	Mini Gator

THREE ALLIGATOR CLIPS TO WE-310 PHONE PLUG (PJ-051 EQUIVALENT)

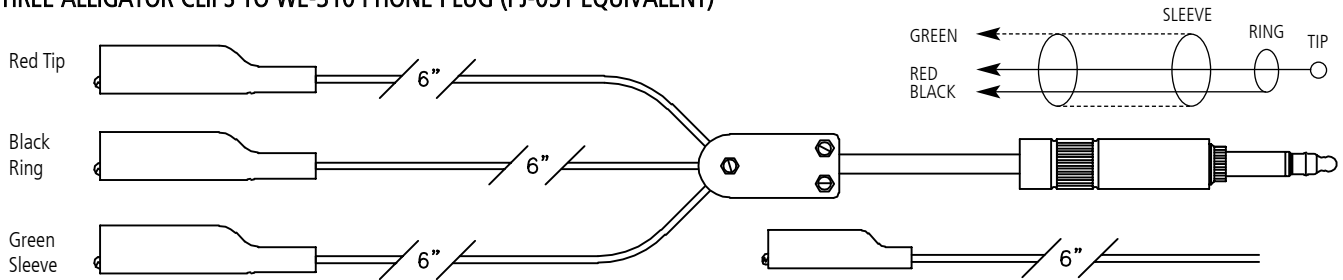

Cable with Part No. 9274 Standard Alligators

Part No.	Cable	Tip	Ring	Sleeve
2528-(lgth)	2100 Series	Std. Gator	Std. Gator	Std. Gator

Cable with Part No. 9275 Miniature Alligators

Part No.	Cable	Tip	Ring	Sleeve
2528 M-(lgth)	2100 Series	Mini Gator	Mini Gator	Mini Gator

SHIELDED BALANCE LINE, DOUBLE BANANA PLUGS TO WE-310 PHONE PLUG (PJ-051 EQUIVALENT)



18 AWG
4" Lead Green

Standard Lengths Available:

Part No.	Cable
2503-(lgth)	2200 Series

18"	45cm	36"	90cm
24"	60cm	48"	120cm
30"	75cm	60"	150cm